

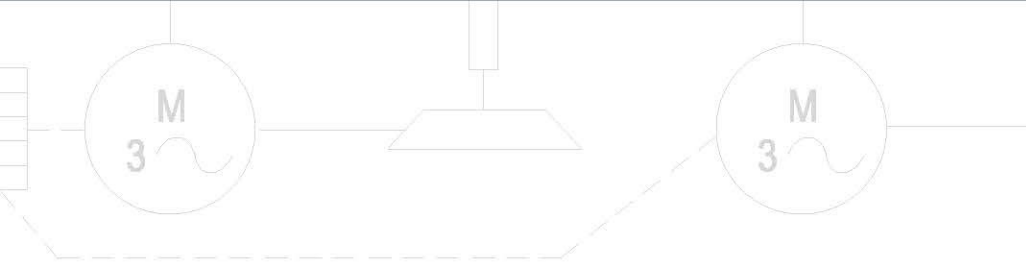

Automation Soft-Starters

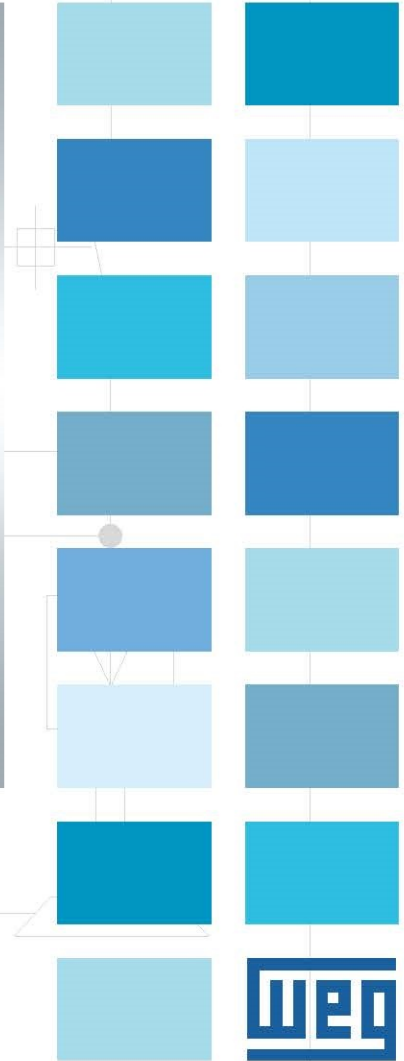

Soft-Starters

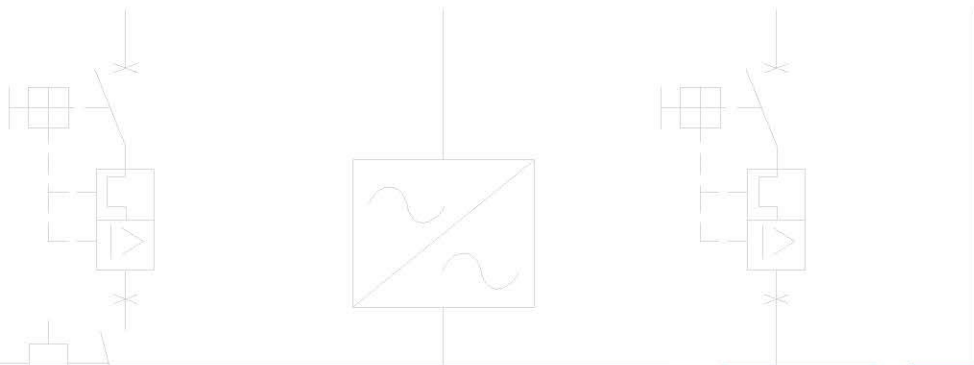

Soft-starters are static starters that accelerate, decelerate and protect three-phase induction motors. The control of the voltage applied to the motor by means of adjustments to the firing angle of thyristors allows the soft-starter to start and stop an electric motor smoothly. With adequate adjustments of the variables, the torque produced is adjusted to the needs of the load, so that the required current is going to be the lowest possible for the starting procedure.

Designed for exclusively industrial or professional use WEG soft-starters are micro processed, fully digital, designed to ensure the best start and stop performance of induction motors, presenting itself as a complete and low-cost solution. The human-machine interface allows easy adjustment of the parameters which helps on the set up and operation. The soft-starter line is top-notch in motor starting and stopping with features that allow the starting, stopping and protection of electric motors in an easy and efficient manner.



Comparison of electric motor start-up methods

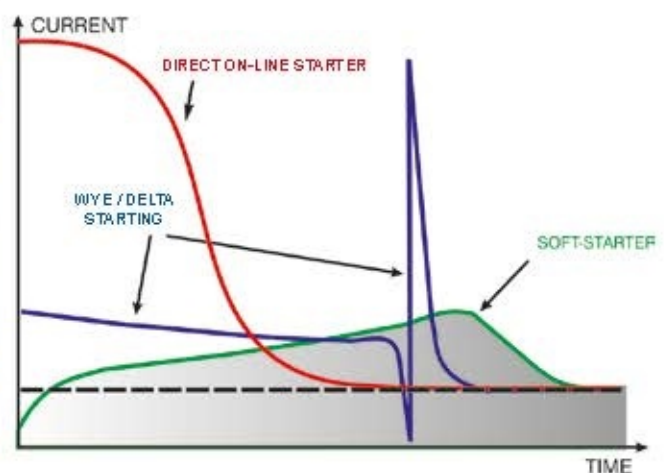



SSW05

The SSW05 Plus Micro Soft-Starters, with DSP control (Digital Signal Processor) have been designed to supply excellent performance during start and stop of electric motors with an excellent cost effectiveness ratio. The Operator Interface allows easy parameter setting, simplifying the start-up and operation activities. The SSW05 Plus Micro Soft-Starters are compact, optimizing space in electrical panels. The SSW05 Plus already incorporates protection for the driven motor.

Benefits

- Reduction of stress on couplings and other transmission devices during start (gear boxes, sheaves)
- Extended lifetime of motor and mechanical components due to reduced mechanical stress
- Easy operation, programming and maintenance
- Simple electrical wiring
- Built-in bypass providing size reduction and energy saving
- Operation in ambient up to 55 °C (122 °F)

Applications

- Bladed vacuum pumps
- Centrifugal pumps
- Screw compressor (relief start)
- Axial fans (low inertia and low load)

Certifications



SSW05 Wiring Diagram

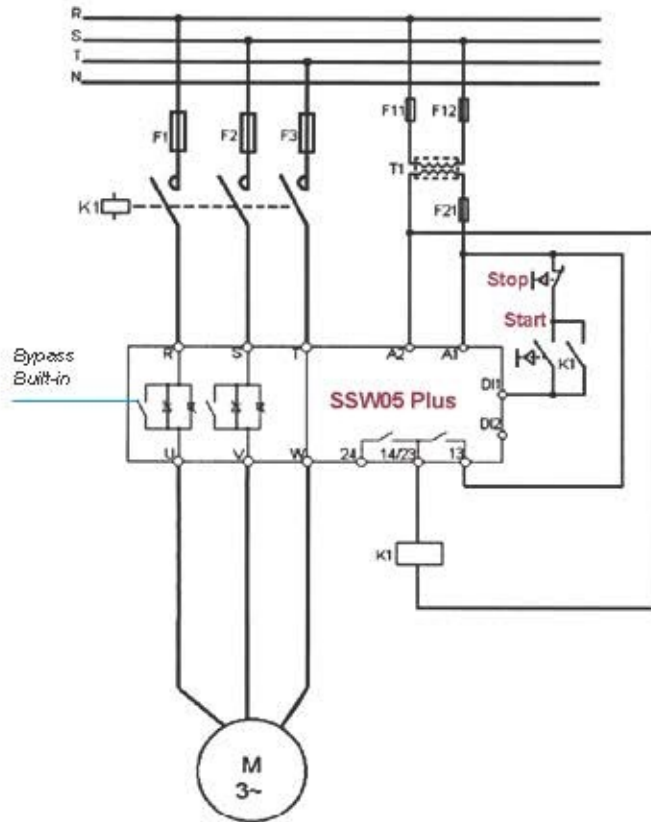

Settings and Indications

Dip switch to enable/disable the motor protections

LEDs to indicate fault trips

LEDs to indicate the starter status

Potentiometers for pedestal voltage, acceleration/deceleration time and motor current settings.

Output to motor

Three phase power supply

Electronic power supply and digital inputs

Serial or remote HMI connector

Relay outputs



SSW05 - Keypad

Remote Human-Machine Interface for remote operation on panel door or machine console. The copy function added to the keypad allows for loading of same parameter setting from one soft-starter to another. It gives reliability for applications where the same parameters settings is desired for more than one soft-staters.

-  Start the soft-starter
-  Stop the soft-starter. Resets the soft-starter after a fault trip has occurred
-  Scroll up parameters or parameter value
-  Scroll down parameters or parameter value
-  Parameter content access/escape/enter



Model	Model
CAB-RS-1	1 m cable for serial remote HMI
CAB-RS-2	2 m cable for serial remote HMI
CAB-RS-3	3 m cable for serial remote HMI
CAB-RS-5	5 m cable for serial remote HMI
CAB-RS-7.5	7.5 m cable for serial remote HMI
CAB-RS-10	10 m cable for serial remote HMI
HMI-SSW05-RS	Remote HMI for CAB-RS cable up to 3 m

SuperDrive - Software

Windows-based software for setting parameters, control and monitoring SSW05 soft-starters.

It allows setting parameters up on-line directly in the soft-starters and off-line programming in the software.

Possibility to store user parameters files from installed SSW05 soft-starters.

The communication between the soft-starter and the computer is provided through RS232 serial interface.



SSW05 - Models



SSW05 - Drive Ratings

The tables below present the expected motor power for each soft-starter model under light load application (e.g.: centrifugal pump). However, for the proper selection of soft-starters, please use the SDW software.

Use the motor power ratings below only as a guidance. Motor rated currents may vary with speed and manufacturer.

IEC motor powers are based on WEG 4-pole motors; NEMA motor powers are based on NEC table 430-150.

Motor Voltages Between 220 V and 460 V

Model	Output current	IEC - 50 Hz		IEC - 60 Hz		NEMA - 60 Hz	
		220 V 230 V	380 V 415 V	220 V 230 V	440 V 460 V	230 V	460 V
		A	KW	KW	HP	HP	HP
SSW050003T2246	3	0.55	1.1	1	1.5	0.5	1.5
SSW050010T2246	10	2.2	4	3	7.5	3	5
SSW050016T2246	16	4	7.5	5	10	5	10
SSW050023T2246	23	5.5	11	7.5	15	7.5	15
SSW050030T2246	30	7.5	15	10	20	10	20
SSW050045T2246	45	11	22	15	30	15	30
SSW050060T2246	60	15	30	20	40	20	40
SSW050085T2246	85	22	45	30	60	30	60

Motor Voltages Between 525 V and 575 V

Model	Output current	IEC	NEMA
		50 Hz 525 V	60 Hz 575 V
		A	KW
SSW050003T4657	3	1.5	2
SSW050010T4657	10	5.5	7.5
SSW050016T4657	16	9.2	10
SSW050023T4657	23	15	20
SSW050030T4657	30	18.5	25
SSW050045T4657	45	30	40
SSW050060T4657	60	37	50
SSW050085T4657	85	55	75

SSW05 - Dimensions and Weight

Model	Frame size	Dimensions mm (in)			Weight kg (lb)	Degree of protection	Inside delta (6 cables) connection	Internal bypass
		H	W	D				
SSW050003T22 46	1	130 (5.12)	59 (2.32)	145 (5.71)	0.74 (1.63)	IP00	No	Yes
SSW050010T22 46								
SSW050016T22 46								
SSW050023T22 46								
SSW050030T22 46								
SSW050045T22 46	2	185 (7.28)	79 (3.11)	172 (2.79)	1.67 (3.68)	IP00	No	Yes
SSW050060T22 46								
SSW050085T22 46								
SSW050003T4657	1	130 (5.12)	59 (2.32)	145 (5.71)	0.74 (1.63)	IP00	No	Yes
SSW050010T4657								
SSW050016T4657								
SSW050023T4657								
SSW050030T4657								
SSW050045T4657	2	185 (7.28)	79 (3.11)	172 (2.79)	1.67 (3.68)	IP00	No	Yes
SSW050060T4657								
SSW050085T4657								

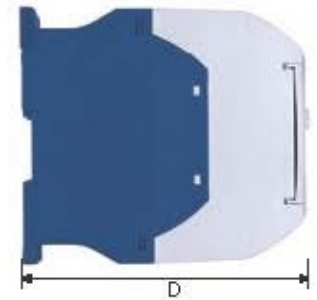

Mechanical Mounting

Size	Width W (mm)		Height H		Depth D (mm)	Mounting A (mm)	Mounting B (mm)	Mounting C (mm)	Mounting
	W	Wa	H	Ha					
1	59	60.4	130	130.7	145	51	122	61	Bold M4/Rail
2	79	80.4	185	185.7	172	71	177	99	Bold M4/Rail

Note: Wa, Ha, Mounting (only for setting with screw).

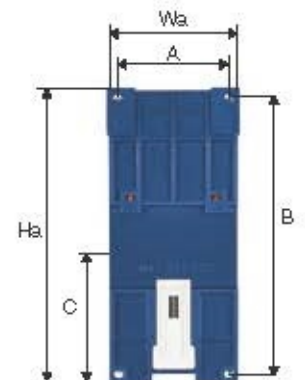

SSW05 Plus - Technical Data

Power supply	Voltage	220 - 460 V ac (+10%, -15%) 460 - 575 V ac (+10%, -15%)
	Frequency	50 / 60 Hz
	Electronic supply	Switched mode power supply (90 - 250 V ac)
	Enclosure	Degree of protection
Control	Method	Motor voltage variation
	CPU	DSP microcontroller
Starting duty cycle	Standard	300% (3 x I _{no.m.}) during 10s, 4 starts per hour
Inputs	Digital	01 input for starting and stopping
		01 input for error reset
Outputs	Digital	01 relay output for full voltage indication (bypass)
		01 relay output for operation indication
Communication	Serial interface	RS232C
Safety	Protections	Motor overload
		Phase sequency
		Phase loss
		Locked rotor
		SCRs overload
		Overcurrent
		Internal fault (watchdog)
Functions	Starting voltage	30 - 80% of the rated voltage
Resources	Programmable acceleration ramp	1 - 20s
	Programmable deceleration ramp	Off - 20s
	Motor rated current and soft-starter rated current ratio	30 - 100%
Ambient	Temperature	0...55 °C - standard operation at rated current
	Humidity	5...90% non condensing
	Altitude	0...1,000 m (3,300 ft) - standard operation at rated current 1,000...4,000 m - with current derating (1%/100 m (328 ft) above 1,000 m (3,300 ft))
Finishing	Colour	Frost gray (cover) and blue (base)
Installation	Fastening	Fastening by bolts or assembling on DIN 35 mm rail
Conformities / standards	Safety	UL 508 Standard - Industrial Control Equipment / IRAM
	Low voltage	IEC 60947-4-2
	EMC	EMC Directive 89 / 336 / EEC - Industrial Environment

WEG Soft-Starters - Selection and Simulation Software - SDW

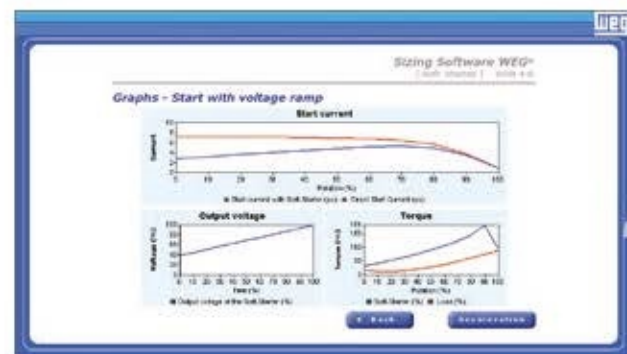

The SDW Software will find the suitable soft-starter for your application, using the WEG motor database. The SDW simulates the start-up and show acceleration graphs with the selected soft-starter.

Free SDW software on our site
www.weg.net

SSW05 - Ordering Code Information



1 - Soft-starter line SSW05

2 - Rated output current:

0003 = 3 A
 0010 = 10 A
 0016 = 16 A
 0023 = 23 A
 0030 = 30 A
 0045 = 45 A
 0060 = 60 A
 0085 = 85 A

3 - Input power supply voltage: T= three-phase

4 - Power supply voltage: 2246 = 220...460 V 4667 = 460...575 V

5 - Product manual language: P = portuguese E = english S = spanish G = german

6 - Product version

P = plus

7 - Special hardware

Blank = standard (not available)
 Hx = optional version x (H1...Hn)

8 - Special software

Blank = standard (not available)
 Sx = optional version x (S1...Sn)

9 - Code end

Z = end of coding





24/7 Technical Support

for Drives and Soft Starters

1-877-WEG-DRIV
(934-3748)

www.weg.net

Gol Pumps Technology INC

3750 NW 114 Ave No: 6
zip : 33178 Miami FL. USA

Service Department

Tel: +1 (786) 615 - 8984

Email : info@golpumps.com

WWW.golpumps.us



WEG Electric Corp.
6655 Sugarloaf Parkway
Duluth, GA 30096
Phone: 1-800-ASK-4WEG
web: www.weg.net



M
3

Soft-Starters

M
3

