

# SMART 750

Handy Pump

60 Hz

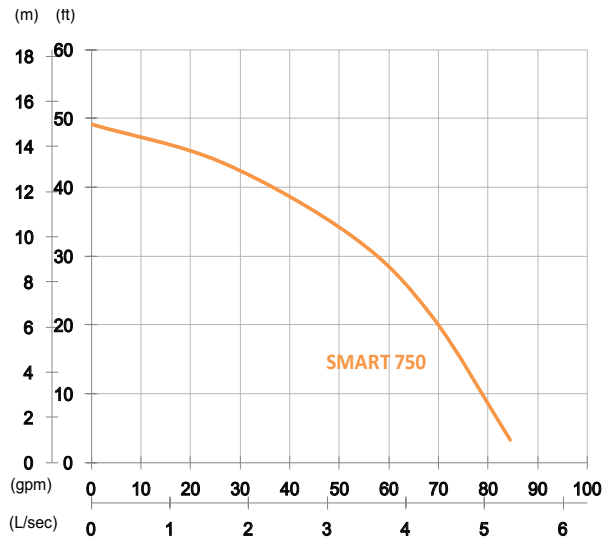

Shaft Speed : 3450 rpm

Outlet : 50mm, 2in

OUTPUT	HEAD	FLOW
0.75 kW	Rated : 10m, 33ft	Rated : 3.3 L/s, 53 gpm
1 HP	Max : 15m, 49ft	Max : 5.3 L/s, 85 gpm

Solid Passage : 7mm, 0.3in

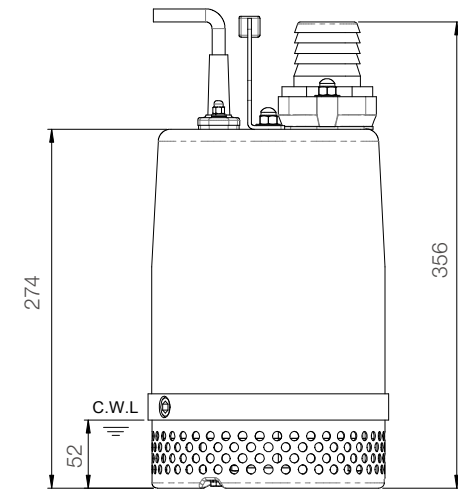
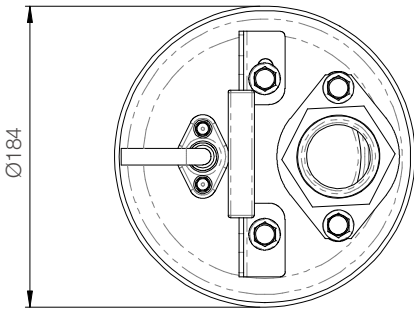

unit : mm

Weight : 14kg / 31 lbs

Pump Type	Electric Submersible Pumps	
	1-Phase, 110V or 220V	
Motor	Type	Induction Motor
	Poles	2 Pole
	Insulation	Class F
	Protector	Circle Thermal Protector
	Starter	1-Phase • Capacitor-Run
Lubricant	Food Grade (ISO VG32)	
Impeller Type	Opened	
Shaft Seal	Double Mechanical Seal	
	Silicon Carbide VS Ceramic / Carbon	
Bearings	C3 Shielded ball bearings	
Cable	PVC (CSA Certified) / H07RN-F	
	6m (20ft) or longer upon request.	
Materials	Pump Casing	Gray Iron
	Impeller	Gray Iron
	Motor Frame	Stainless Steel
	Motor Shaft	Stainless Steel
	Outer Case	Stainless Steel
	Strainer	Stainless Steel
Max. Liquid Temperature	40°C (104°F)	
Max. Submersion Depth	20m (66ft)	
pH Range	pH 5 - pH 8	